

IM3116  
10/2019  
REV02

# BESTER 190C MULTI

---

## OPERATOR'S MANUAL



ENGLISH

---

**LINCOLN**<sup>®</sup>  
**ELECTRIC**

Lincoln Electric Bester Sp. z o.o.  
ul. Jana III Sobieskiego 19A, 58-263 Bielawa, Poland  
[www.lincolnelectric.eu](http://www.lincolnelectric.eu)

**THANKS!** For having chosen the QUALITY of Lincoln Electric products.

- Please Examine Package and Equipment for Damage. Claims for material damaged in shipment must be notified immediately to the dealer.
- For future reference record in the table below your equipment identification information. Model Name, Code & Serial Number can be found on the machine rating plate.

Model Name:
Code & Serial Number:
Date & Where Purchased

## ENGLISH INDEX

Technical Specifications .....	1
Electromagnetic Compatibility (EMC) .....	2
Safety .....	3
Introduction .....	4
Installation and Operator Instructions .....	4
WEEE .....	11
Spare Parts .....	11
Authorized Service Shops Location .....	11
Electrical Schematic .....	11
Accessories .....	12

# Technical Specifications

NAME		INDEX	
BESTER 190C MULT		B18259-1	
<b>INPUT - SINGLE PHASE ONLY</b>			
Standard Voltage/Phase/ Frequency and Fuse type	Generator required (recommended)	Maximum Input Current	Input Effective Current
230+/-15% / 1/50/60 Hz 16A (I <sub>2</sub> >160A)	>10 kVA	38A	16A
<b>RATED OUTPUT – DC ONLY</b>			
Mode	Duty Cycle <sup>(1)</sup>	Amperes	Volts at Rated Amperes
GMAW	20%	180A**	23V
	60%	115A	19.8V
	100%	90A	18.5V
SMAW	15%	180A**	27.2V
	60%	95A	23.8V
	100%	75A	23.0V
GTAW	25%	180A**	17.2V
	60%	120A	14.8.4V
	100%	90A	13.6V
The duty cycle above is about 40°C			
<b>OUTPUT RANGE</b>			
Mode	Open Circuit Voltage (peak)	Welding Current Range	Welding Voltage Range
GMAW	U <sub>0</sub> 88V	30A ÷ 180A	15.5V ÷ 23V
SMAW	U <sub>0</sub> 88V	15A ÷ 180A	20.6V ÷ 27.2V
GTAW	U <sub>0</sub> 88V	15A ÷ 180A	10.6V ÷ 17.2V
<b>OTHER PARAMETERS</b>			
Power Factor	Efficiency and Idle power	Protection Class	Insulation Class
0,75	86% 24W	IP21S	F
<b>PHYSICAL DIMENSIONS</b>			
Length	Width	Height	Weight (Net)
480mm	220mm	305mm	13kg
<b>TEMPERATURE RANGE</b>			
Operating Temperature Range		-10°C ~ +40°C(14°F~104°F)	
Storage Temperature Range		-25°C ~ +55°C(-13°F~131°F)	

(1) Based upon 10 minute time period (i.e., for 30% duty cycle, it is 3 minutes on and 7 minutes off)

**Note:** The above parameters are subject to change with the improvement of machine

\*\* When welding with maximum current I<sub>2</sub>>160A replace input plug with one>16A.

# Electromagnetic Compatibility (EMC)

11/04

This machine has been designed in accordance with all relevant directives and standards. However, it may still generate electromagnetic disturbances that can affect other systems like telecommunications (telephone, radio, and television) or other safety systems. These disturbances can cause safety problems in the affected systems. Read and understand this section to eliminate or reduce the amount of electromagnetic disturbance generated by this machine.



This machine has been designed to operate in an industrial area. To operate in a domestic area it is necessary to observe particular precautions to eliminate possible electromagnetic disturbances. The operator must install and operate this equipment as described in this manual. If any electromagnetic disturbances are detected the operator must put in place corrective actions to eliminate these disturbances with, if necessary, assistance from

Lincoln Electric.

Before installing the machine, the operator must check the work area for any devices that may malfunction because of electromagnetic disturbances. Consider the following.

- Input and output cables, control cables, and telephone cables that are in or adjacent to the work area and the machine.
- Radio and/or television transmitters and receivers. Computers or computer controlled equipment.
- Safety and control equipment for industrial processes. Equipment for calibration and measurement.
- Personal medical devices like pacemakers and hearing aids.
- Check the electromagnetic immunity for equipment operating in or near the work area. The operator must be sure that all equipment in the area is compatible. This may require additional protection measures.
- The dimensions of the work area to consider will depend on the construction of the area and other activities that are taking place.

Consider the following guidelines to reduce electromagnetic emissions from the machine.

- Connect the machine to the input supply according to this manual. If disturbances occur it may be necessary to take additional precautions such as filtering the input supply.
- The output cables should be kept as short as possible and should be positioned together. If possible connect the work piece to ground in order to reduce the electromagnetic emissions. The operator must check that connecting the work piece to ground does not cause problems or unsafe operating conditions for personnel and equipment.
- Shielding of cables in the work area can reduce electromagnetic emissions. This may be necessary for special applications.

## **WARNING**

The Class A equipment is not intended for use in residential locations where the electrical power is provided by the public low-voltage supply system. There may be potential difficulties in ensuring electromagnetic compatibility in those locations, due to conducted as well as radiated disturbances.

















## **WARNING**

This equipment does not comply with IEC 61000-3-12. If it is connected to a public low-voltage system, it is responsibility of the installer or user of the equipment to ensure, by consultation with the distribution network operator if necessary, that the equipment may be connected.

## **WARNING**

This equipment must be used by qualified personnel. Be sure that all installation, operation, maintenance and repair procedures are performed only by qualified person. Read and understand this manual before operating this equipment. Failure to follow the instructions in this manual could cause serious personal injury, loss of life, or damage to this equipment. Read and understand the following explanations of the warning symbols. Lincoln Electric is not responsible for damages caused by improper installation, improper care or abnormal operation.

	<p><b>WARNING:</b> This symbol indicates that instructions must be followed to avoid serious personal injury, loss of life, or damage to this equipment. Protect yourself and others from possible serious injury or death.</p>
	<p><b>READ AND UNDERSTAND INSTRUCTIONS:</b> Read and understand this manual before operating this equipment. Arc welding can be hazardous. Failure to follow the instructions in this manual could cause serious personal injury, loss of life, or damage to this equipment.</p>
	<p><b>ELECTRIC SHOCK CAN KILL:</b> Welding equipment generates high voltages. Do not touch the electrode, work clamp, or connected work pieces when this equipment is on. Insulate yourself from the electrode, work clamp and connected work pieces.</p>
	<p><b>ELECTRICALLY POWERED EQUIPMENT:</b> Turn off input power using the disconnect switch at the fuse box before working on this equipment. Ground this equipment in accordance with local electrical regulations.</p>
	<p><b>ELECTRICALLY POWERED EQUIPMENT:</b> Regularly inspect the input, electrode, and work clamp cables. If any insulation damage exists replace the cable immediately. Do not place the electrode holder directly on the welding table or any other surface in contact with the work clamp to avoid the risk of accidental arc ignition.</p>
	<p><b>ELECTRIC AND MAGNETIC FIELDS MAY BE DANGEROUS:</b> Electric current flowing through any conductor creates electric and magnetic fields (EMF). EMF fields may interfere with some pacemakers and welders having a pacemaker shall consult their physician before operating this equipment.</p>
	<p><b>CE COMPLIANCE:</b> This equipment complies with the European Community Directives.</p>
	<p><b>ARTIFICIAL OPTICAL RADIATION:</b> According with the requirements in 2006/25/EC Directive and EN 12198 Standard, the equipment is a category 2. It makes mandatory the adoption of Personal Protective Equipment (PPE) having filter with a protection degree up to a maximum of 15, as required by EN169 Standard.</p>
	<p><b>FUMES AND GASES CAN BE DANGEROUS:</b> Welding may produce fumes and gases hazardous to health. Avoid breathing these fumes and gases. To avoid these dangers the operator must use enough ventilation or exhaust to keep fumes and gases away from the breathing zone.</p>
	<p><b>ARC RAYS CAN BURN:</b> Use a shield with the proper filter and cover plates to protect your eyes from sparks and the rays of the arc when welding or observing. Use suitable clothing made from durable flame-resistant material to protect you skin and that of your helpers. Protect other nearby personnel with suitable, non-flammable screening and warn them not to watch the arc nor expose themselves to the arc.</p>
	<p><b>WELDING SPARKS CAN CAUSE FIRE OR EXPLOSION:</b> Remove fire hazards from the welding area and have a fire extinguisher readily available. Welding sparks and hot materials from the welding process can easily go through small cracks and openings to adjacent areas. Do not weld on any tanks, drums, containers, or material until the proper steps have been taken to insure that no flammable or toxic vapors will be present. Never operate this equipment when flammable gases, vapors or liquid combustibles are present.</p>
	<p><b>WELDED MATERIALS CAN BURN:</b> Welding generates a large amount of heat. Hot surfaces and materials in work area can cause serious burns. Use gloves and pliers when touching or moving materials in the work area.</p>

	<p><b>CYLINDER MAY EXPLODE IF DAMAGED:</b> Use only compressed gas cylinders containing the correct shielding gas for the process used and properly operating regulators designed for the gas and pressure used. Always keep cylinders in an upright position securely chained to a fixed support. Do not move or transport gas cylinders with the protection cap removed. Do not allow the electrode, electrode holder, work clamp or any other electrically live part to touch a gas cylinder. Gas cylinders must be located away from areas where they may be subjected to physical damage or the welding process including sparks and heat sources.</p>
	<p>: There are moving mechanical parts in this machine, which can cause serious injury. Keep your hands, body and clothing away from those parts during machine starting, operating and servicing.</p>
	<p><b>SAFETY MARK:</b> This equipment is suitable for supplying power for welding operations carried out in an environment with increased hazard of electric shock.</p>

The manufacturer reserves the right to make changes and/or improvements in design without upgrade at the same time the operator's manual.

## Introduction

The welding machines **BESTER 190C MULTI** enables welding:

- GMAW (MIG/MAG)
- FCAW-SS
- SMAW (MMA)

The following equipment has been added to **BESTER 190C MULTI** :

- Work lead – 3m
- GMAW welding gun – 3m

- Driving roll V0.6/V0,8 for solid wire (mounted in the wire feeder).

For GMAW and FCAW-SS process, the technical specification describes:

- Type of welding wire
- Wire diameter

Recommended equipment, which can be bought by user, was mentioned in the chapter "Accessories".

## Installation and Operator Instructions

Read this entire section before installation or operation of the machine.

### Location and Environment

This machine will operate in standard environments. However, it is important that simple preventative measures are followed to assure long life and reliable operation:

- Do not place or operate this machine on a surface with an incline greater than 15° from horizontal.
- Do not use this machine for pipe thawing.
- This machine must be located where there is free circulation of clean air without restrictions for air movement to and from the air vents. Do not cover the machine with paper, cloth or rags when switched on.
- Dirt and dust that can be drawn into the machine should be kept to a minimum.
- This machine has a protection rating of IP21. Keep it dry when possible and do not place it on wet ground or in puddles.
- Locate the machine away from radio controlled machinery. Normal operation may adversely affect the operation of nearby radio controlled machinery, which may result in injury or equipment damage. Read the section on electromagnetic compatibility in this manual.
- Do not operate in areas with an ambient temperature greater than 40°C.

### Duty cycle and Overheating

The duty cycle of a welding machine is the percentage of time in a 10 minute cycle at which the welder can operate the machine at rated welding current.

Example: 60% duty cycle

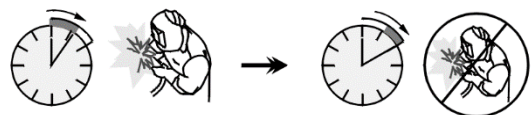

Welding for 6 minutes.

Break for 4 minutes.

Excessive extension of the duty cycle will cause the thermal protection circuit to activate. The machine is protected from overheating by a temperature sensor.

## Input Supply Connection

### WARNING

Only a qualified electrician can connect the welding machine to the supply network. Installation had to be made in accordance with the appropriate National Electrical Code and local regulations.

Check the input voltage, phase and frequency supplied to this machine before turning it on. Verify the connection of ground wires from the machine to the input source. The welding machine **BESTER 190C MULTI**, must be connected to a correctly installed plug-in socket with an earth pin.

Input voltage is 230V, 50/60Hz. For more information about input supply refer to the technical specification section of this manual and to the rating plate of the machine.

Make sure that the amount of mains power available from the input supply is adequate for normal operation of the machine. The necessary delayed fuse (or circuit breaker with "B" characteristic) and cable sizes are indicated in the technical specification section of this manual.

### WARNING

The welding machine can be supplied from a power generator of output power at least 30% larger than input power of the welding machine.

### WARNING

When powering welder from a generator be sure to turn off welder first, before generator is shut down, in order to prevent damage to welder!

## Output Connections

Refer to points [7], [8] and [9] of the Figure 2.

## Power Source Placement and connections

### WARNING

Avoid excessive dust, acid and corrosive materials in the air.

Keep protected from rain and direct sun when in use outdoors.

There should be 500 mm space about for the welding machine to have good ventilation.

Use adequate ventilation when in confined areas.

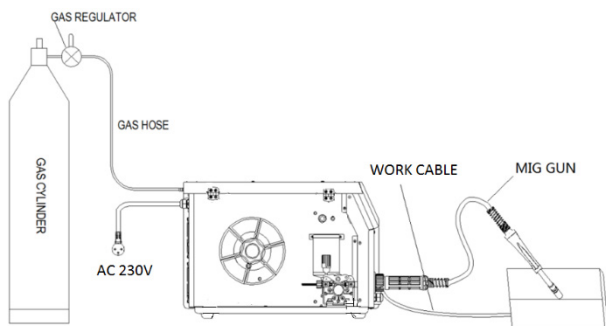

Figure 1

## Controls and Operational Features Front Panel



Figure 2

1. Amp/WFS display
2. Voltage/arc force display
3. Power indicator / Warning indicator
4. Wire inching Button
5. 2T/4T selection
6. Weld mode(MIG/GTAW/MMA) selection
7. Inductance control knob
8. Output terminal (Negative)
9. Output terminal (Active)
10. Euro gun connector
11. Voltage/arc force control knob
12. Amp/WFS control knob



### Note:

- The 'protection indicator light' will come on if the duty cycle is exceeded. It shows that the inner temperature is over the permitted level, the machine should be stopped being used to allow it cool down. Welding can continue after the 'protection indicator light' is off.
- The power source should be switched off when not in use.
- Welders should wear protective clothing and welding helmet to prevent injury from arc and thermal radiation.
- Care should be taken so as not to expose others to the welding arc. Use of screening is recommended.
- Do not weld near Inflammable or explosive materials.

### 7. Knob Control: In GMAW, this knob controls [7]:

GMAW process		<u>Inductance:</u> Arc control is controlled by this knob. If the value is higher, the arc will be softer and during welding is less spatters.
--------------	--	--

### 11. Voltage/Arc Force control: Depending on welding process, this knob controls [11]:

GMAW process		The welding load voltage and set by this knob (also during welding).
SMAW process		<u>ARC FORCE:</u> The output current is temporarily increased to clear short circuit connections between the electrode and the workpiece.

12. Wire Feed Speed / Current Knob Control: Depending on welding process, this knob controls [12]:

GMAW process	$\frac{m}{min}$	Wire feed speed WFS: Value in percentage of nominal value wire feed speed (m/min).
SMAW process	<b>A</b>	The welding current is set by this knob (also during welding).

### Rear Panel

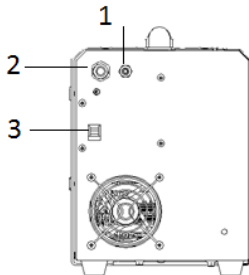

Figure 3

1. Gas connector
2. Input power cord
3. Power switch

#### ! WARNING

When the machine is switched again on, last welding process will be recalled.

#### ! WARNING

If the push-button is pushed in GMAW process in, the output terminals will lived.

#### ! WARNING

During SMAW process, the output terminals are still lived.

## The installation and connection

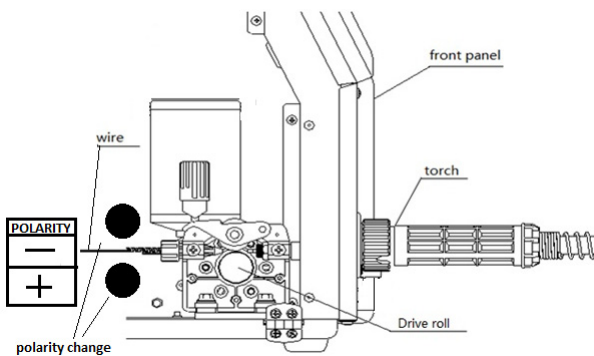

Figure 4

#### ! WARNING

Positive (+) polarity is set at the factory.

If the welding polarity has to be changed, user should:

- Switch off the machine.
- Determine the polarity for the electrode to be used (or wire). Consult the data for this information.
- Select and set the correct polarity.

#### ! WARNING

Before welding check the polarity for using electrodes and wires.

#### ! WARNING

The machine must be used with the door completely closed during welding.

#### ! WARNING

Not use handle to move the machine during work.

## Loading the Electrode Wire

- Turn the machine off.
- Open the side cover of the machine.
- Unscrew the locking nut of the sleeve.
- Load the spool with the wire on the sleeve such that the spool turns anticlockwise when the wire is fed into the wire feeder.
- Make sure that the spool locating pin goes into the fitting hole on the spool.
- Screw in the fastening cap of the sleeve.
- Put on the wire roll using the correct groove corresponding to the wire diameter.
- Free the end of the wire and cut off the bent end making sure it has no burr.

#### ! WARNING

Sharp end of the wire can hurt.

- Rotate the wire spool anticlockwise and thread the end of the wire into the wire feeder as far as the Euro socket.
- Adjust force of pressure roll of the wire feeder properly.

## Adjustments of Brake Torque of Sleeve

To avoid spontaneous unrolling of the welding wire the sleeve is fitted with a brake.

Adjustment is carried by rotation of its Allen screw M8, which is placed inside of the sleeve frame after unscrewing the fastening cap of the sleeve.

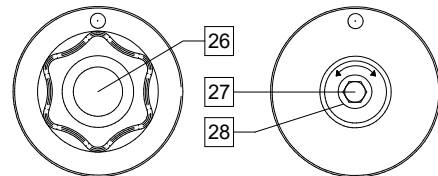

Figure 5

26. Fastening cap.
27. Adjusting Allen screw M8.
28. Pressing spring.

Turning the Allen screw M8 clockwise increases the spring tension and you can increase the brake torque

Turning the Allen screw M8 anticlockwise decreases the spring tension and you can decrease the brake torque.

After finishing of adjustment, you should screw in the fastening cap again.



## Adjusting of Force of Pressure Roll Force

The pressure arm controls the amount of force the drive rolls exert on the wire.

Pressure force is adjusted by turning the adjustment nut clockwise to increase force, counterclockwise to decrease force. Proper adjustment of pressure arm gives the best welding performance.

### WARNING

If the roll pressure is too low the roll will slide on the wire. If the roll pressure is set too high the wire may be deformed, which will cause feeding problems in the welding gun. The pressure force should be set properly. Decrease the pressure force slowly until the wire just begins to slide on the drive roll and then increase the force slightly by turning of the adjustment nut by one turn.

## Inserting Electrode Wire into Welding Torch

- Turn the welding machine off.
- Depending on welding process, connect the proper gun to the euro socket, the rated parameters of the gun and of the welding machine should be matched.
- Remote the nozzle from the gun and contact tip or protection cap and contact tip. Next, straighten the gun out flat.
- Turn the welding machine on.
- Depress the gun trigger to feed the wire through the gun liner until the wire comes out of the threaded end.
- When trigger is released spool of wire should not unwind.
- Adjust wire spool brake accordingly.
- Turn the welding machine off.
- Install a proper contact tip.
- Depending on the welding process and the type of the gun, install the nozzle (GMAW process) or protection cap (FCAW-SS process).

### WARNING

Take precaution to keep eyes and hands away from the end of the gun while the wire is being come out of the threaded end.

## Changing Driving Rolls

### WARNING

Turn the input power off of the welding power source before installation or changing drive rolls.

**BESTER 190C MULTI** is equipped with drive roll V0.6/V0.8 for steel wire. For others wire sizes, is available the proper drive rolls kit (see "Accessories" chapter) and follow instructions:

- Turn the welding machine off.
- Release the pressure roll lever [1].
- Unscrew the fastening cap [3].
- Change the drive roll [2] with the compatible ones corresponding to the used wire.

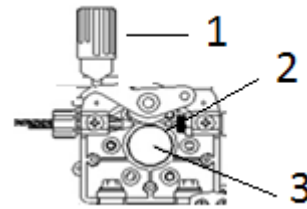

Figure 6

- Screw fastening cap [3].

## Gas Connection

A gas cylinder must be installed with a proper flow regulator. Once a gas cylinder with a flow regulator has been securely installed, connect the gas hose from the regulator to the machine gas inlet connector. Refer to point [1] of the Figure 3.

### WARNING

The welding machine supports all suitable shielding gases including carbon dioxide, argon and helium at a maximum pressure of 5,0 bars.

**Note:** When using the GTAW lift process, connect the gas hose from the GTAW torch to the gas regulator on the shield gas cylinder.

## Welding GMAW, FCAW-SS Process

**BESTER 190C MULTI** can be used to welding GMAW and FCAW-SS process.

## Preparation the Machine for Welding GMAW and FCAW-SS Process.

Procedure of begin welding of GMAW or FCAW-SS process:

- Determine the wire polarity for the wire to be used. Consult the wire data for this information.
- Connect output the gas-cooled gun to GMAW / FCAW-SS process to Euro Socket [10] Figure 2.
- Depending on the using wire, connect the work lead to output socket [8] or [9] Figure 2.
- Connect the work lead to the welding piece with the work clamp.
- Install the proper wire.
- Install the proper drive roll.
- Make a sure, if it is needed (GMAW process), that the gas shield has been connected.
- Turn the machine on.
- Push the gun trigger to feed the wire through the gun liner until the wire comes out of the threaded end.
- Install a proper contact tip.
- Depending on the welding process and the type of the gun, install the nozzle (GMAW process) or protection cap (FCAW-SS process).
- Close the left side panel.
- Set welding mode to GMAW [6] Figure 2
- The welding machine is now ready to weld.
- By applying the principle of occupational health and safety at welding, welding can be begun.

## Welding GMAW, FCAW-SS Process in Manual Mode

In **BESTER 190C MULTI** can be set:

BESTER 190C MULTI	
•	The welding load voltage
•	WFS
•	Inductance

**The 2-Step - 4-Step** changes the function of the gun's trigger.

- 2 Step trigger operation turns welding on and off in direct response to the trigger. Welding process is performed when the gun's trigger is pulled.
- 4-Step mode allows to continue welding, when the gun's trigger is released. To stop welding, the gun's trigger is pulled again. 4-step mode facilitates to making long welds.



### WARNING

4-Step does not work during Spot Welding.

## Welding SMAW (MMA) Process

**BESTER 190C MULTI** does not include the electrode holder with lead necessary for SMAW welding, but the one can be purchased separately.

Procedure of begin welding of SMAW process:

- First turn the machine off.
- Determine the electrode polarity for the electrode to be used. Consult the electrode data for this information.
- Depending on the polarity of using electrode, connect the work lead and the electrode holder with lead to output socket [8] or [9] (Figure 2) and lock them. See the Table 1.

**Table 1.**

		Output socket		
POLARITY	DC (+)	The electrode holder with lead to SMAW	[9]	+
		Work lead	[8]	-
	DC (-)	The electrode holder with lead to SMAW	[8]	-
		Work lead	[9]	+

- Connect the work lead to the welding piece with the work clamp.
- Install the proper electrode in the electrode holder.
- Turn the welding machine on.
- Set welding mode to MMA [6] Figure 2.
- Set the welding parameters.
- The welding machine is now ready to weld.
- By applying the principle of occupational health and safety at welding, welding can be begun.

User can set functions:

BESTER 190C MULTI	
•	The welding current
•	ARC FORCE

## Welding GTAW Process

**BESTER 190C MULTI** can be used to GTAW process with DC (-). Arc ignition can be achieved only by lift TIG method (contact ignition and lift ignition).

**BESTER 190C MULTI** does not include the torch to GTAW welding, but the one can be purchased separately. See "Accessories" chapter.

Procedure of begin welding of GTAW process:

- First turn the machine off.
- Connect GTAW torch to [9] output socket.
- Connect the work lead to [8] output socket.
- Connect the work lead to the welding piece with the work clamp.
- Install the proper tungsten electrode in the GTAW torch.
- Turn the machine on.
- Set up welding mode to GTAW [6] Figure 2
- Set the welding parameters.
- The welding machine is now ready to weld.
- By applying the principle of occupational health and safety at welding, welding can be begun.

## Maintenance

### **WARNING**

For any repair operations, modifications or maintenances, it is recommended to contact the nearest Technical Service Center or Lincoln Electric. Repairs and modifications performed by unauthorized service or personnel will cause, that the manufacturer's warranty will become null and void.

Any noticeable damage should be reported immediately and repaired.

#### **Routine maintenance (everyday)**

- Check condition of insulation and connections of the work leads and insulation of power lead. If any insulation damage exists replace the lead immediately.
- Remove the spatters from the welding gun nozzle. Spatters could interfere with the shielding gas flow to the arc.
- Check the welding gun condition: replace it, if necessary.
- Check condition and operation of the cooling fan. Keep clean its airflow slots.

#### **Periodic maintenance (every 200 working hours but at list once every year)**

Perform the routine maintenance and, in addition:

- Keep the machine clean. Using a dry (and low pressure) airflow, remove the dust from the external case and from the cabinet inside.
- If it is required, clean and tighten all weld terminals.

The frequency of the maintenance operations may vary in accordance with the working environment where the machine is placed.

### **WARNING**

Do not touch electrically live parts.

### **WARNING**

Before the case of welding machine will be removed, the welding machine had to be turned off and the power lead had to be disconnected from mains socket.

### **WARNING**

Mains supply network must be disconnected from the machine before each maintenance and service. After each repair, perform proper tests to ensure safety.

## Customer Assistance Policy

The business of The Lincoln Electric Company is manufacturing and selling high quality welding equipment, consumables, and cutting equipment. Our challenge is to meet the needs of our customers and to exceed their expectations. On occasion, purchasers may ask Lincoln Electric for advice or information about their use of our products. We respond to our customers based on the best information in our possession at that time. Lincoln Electric is not in a position to warrant or guarantee such advice, and assumes no liability, with respect to such information or advice. We expressly disclaim any warranty of any kind, including any warranty of fitness for any customer's particular purpose, with respect to such information or advice. As a matter of practical consideration, we also cannot assume any responsibility for updating or correcting any such information or advice once it has been given, nor does the provision of information or advice create, expand or alter any warranty with respect to the sale of our products

Lincoln Electric is a responsive manufacturer, but the selection and use of specific products sold by Lincoln Electric is solely within the control of, and remains the sole responsibility of the customer. Many variables beyond the control of Lincoln Electric affect the results obtained in applying these types of fabrication methods and service requirements.

Subject to Change – This information is accurate to the best of our knowledge at the time of printing. Please refer to [www.lincolnelectric.com](http://www.lincolnelectric.com) for any updated information.

## Troubleshooting

No.	Problem	Possible Cause	What to do
1	Yellow Thermal Indicator is on	Input voltage is too high ( $\geq 15\%$ )	Switch off power source; Check the main supply. Restart welder when power recovers to normal state.
		Input voltage is too low ( $\leq 15\%$ )	
		Insufficient ventilation.	Improve the ventilation.
		Ambient temperature is too high.	It will automatically recover when the temperature reduces.
		Exceeding the rated duty-cycle.	It will automatically recover when the temperature reduces.
2	Wire feeding motor not working	Potentiometer faulty	Change potentiometer
		Nozzle is blocked.	Change nozzle
		Drive roll is loose.	Increase tension on drive roll
3	Cooling Fan not working or turning very slowly	Switch broken	Replace the switch
		Fan broken	Replace or repair the fan
		Wire broken or disconnected	Check the connection
4	Arc is not stable and spatter is large	Too large contact tip makes the current unsteady	Change to proper contact tip and / or drive roll.
		Too thin power cable makes the power unstable.	Change the power cable.
		Too low input voltage	Correct the input voltage.
		Wire feeding resistance is too large	Clean or replace the liner and keep the gun cable straight.
5	Arc will not start	Work cable broken	Connect / repair work cable
		Work piece has greasy, dirty, rusty or painted	Clean work piece, ensure good electrical contact between work clamp and job.
6	No shielding gas	Torch is not connected properly.	Re-connect the torch.
		Gas pipe is crimped or blocked.	Check gas system.
		Gas hose broken.	Repair or replace
7	Others		Please contact our Field Service Shop.

## WEEE

07/06

English



Do not dispose of electrical equipment together with normal waste!

In observance of European Directive 2012/19/UE on Waste Electrical and Electronic Equipment (WEEE) and its implementation in accordance with national law, electrical equipment that has reached the end of its life must be collected separately and returned to an environmentally compatible recycling facility. As the owner of the equipment, you should get information on approved collection systems from our local representative.

By applying this European Directive you will protect the environment and human health!

## Spare Parts

12/05

### Part list reading instructions

- Do not use this part list for a machine if its code number is not listed. Contact the Lincoln Electric Service Department for any code number not listed.
- Use the illustration of assembly page and the table below to determine where the part is located for your particular code machine.
- Use only the parts marked "X" in the column under the heading number called for in the assembly page (# indicate a change in this printing).

First, read the Part List reading instructions above then refer to the "Spare Part" manual supplied with the machine, which contains a picture-descriptive part number cross-reference).

## Authorized Service Shops Location

09/16

- The purchaser must contact a Lincoln Authorized Service Facility (LASF) about any defect claimed under Lincoln's warranty period.
- Contact your local Lincoln Sales Representative for assistance in locating a LASF or go to [www.lincolnelectric.com/en-gb/Support/Locator](http://www.lincolnelectric.com/en-gb/Support/Locator).

## Electrical Schematic

Refer to the "Spare Part" manual supplied with the machine.

## Accessories

W10429-15-3M	LGS2 150 MIG gun, gas cooled - 3m.
W000010786	Gas nozzle conical Ø12mm.
W000010820	Contact Tip M6x25mm ECu 0.6mm
W000010821	Contact Tip M6x25mm ECu 0.8mm
WP10440-09	Contact Tip M6x25mm ECu 0.9mm
W000010822	Contact Tip M6x25mm ECu 1.0mm
WP10468	Protection cap to FCAW-SS process.
W10529-17-4V	GTAW torch WTT2 17- 4m with valve
W000260684	Lead's KIT to SMAW process:
	The electrode holder with lead to SMAW process - 3m.
	Work lead - 3m.
<b>ROLL KIT FOR SOLID WIRES</b>	
S33444-20	Drive roll V0.6 / V0.8
S33444-21	Drive roll V0.8 / V1.0 (Installed in standard)
<b>ROLL KIT FOR ALUMINIUM WIRES</b>	
S33444-22	Drive roll U0,8 / U1.0
<b>ROLL KIT FOR CORED WIRES</b>	
S33444-23	Drive roll VK0.9 / VK1.1